



Çözüm Ortaklarımız...



ÇEÇEN PLASTİK METAL VE ZEMİN SİSTEMLERİ SAN. TİC. LTD. ŞTİ.

Kayışdağı Cd. No: 45 Atayol Plaza Ataşehir / İstanbul

Tel : (0216) 572 18 19

Fax : (0216) 572 18 20

Gsm: (0555) 961 12 22

info@cecenplastik.com



ÇÖP
KONTEYNERLERİ





CCN360

360 lt'lik Plastik Çöp Konteyneri



CCN240

240 lt'lik Plastik Çöp Konteyneri



CCN 60

60 lt'lik Plastik Çöp Konteyneri



Pedal Sistemi



CCN120 P

120 lt'lik Pedallı Plastik Çöp Konteyneri



CCN50

50 lt'lik Plastik Çöp Konteyneri



Poşet Tutucu



Kilit Sistemi



Atık Kapak

CCN	60 lt.		120 lt.	140 lt.	190 lt.	240 lt.	360 lt.
	Low	High					
Volume (t)	60	60	120	140	190	240	360
Dead Weight (kg)	7.5	10	11	12	14	15	23
Maximum Load (Kg)	40	40	48	56	76	96	136
Total Height (mm)	A	660	940	1060	1060	1060	1080
Total Width (mm)	B	440	440	480	480	525	580
Total Depth (mm)	C	500	500	540	550	630	875
Upper Edge Comb (mm)	D	595	875	870	1010	980	1000
Wheel Diameter (mm)	E	200	200	200	200/250	200/250	200/300

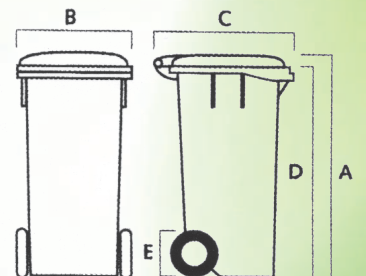



CCN770

770 lt'lik Plastik Çöp Konteyneri

CCN1100

1100 lt'lik Plastik Çöp Konteyneri



Kilit Sistemi



Takip Sistemi

Atık Kapak Modelleri

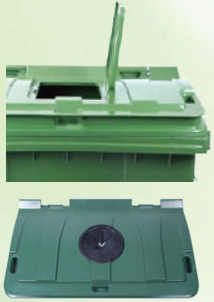

CCN770

Tıbbi Atık Konteyneri



CCN660

600 lt'lik Plastik Çöp Konteyneri

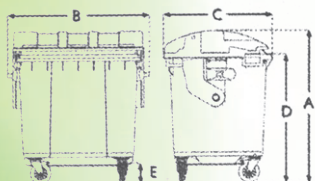
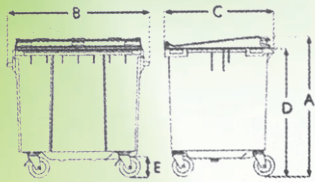

CCN		660 lt.	770 lt.	1000 lt.	1100 lt.	1100 lt.	1200 lt.
				Flat	Flat	Dome	Dome
Volume (t)		667	797	1047	1047	1148	1148
Dead Weight (kg)		43	46	52	52	66	66
Maximum Load (Kg)		310	370	500	500	510	510
Total Height (mm)	A	1190	1350	1335	1335	1460	1460
Total Width (mm)	B	1360	1360	1360	1360	1360	1360
Total Depth (mm)	C	780	780	1030	1030	1050	1050
Upper Edge Comb (mm)	D	1085	1085	1230	1230	1230	1230
Wheel Diameter (mm)	E	200	200	200	200	200	200





CCN 800 LT
Metal Çöp Konteyneri



CCN 600 LT
Metal Çöp Konteyneri



CCN 400 LT
Metal Çöp Konteyneri



CCN 240 LT
Metal Çöp Konteyneri



CCN 120 LT
Metal Çöp Konteyneri

CCN	Lt.	Boy	En	Derinlik	Açıklama
Metal Konteyner	120	90 cm	40 cm	40 cm	TSE 840-2 belgelidir
Metal Konteyner	240	100 cm	50 cm	50 cm	TSE 840-2 belgelidir
Metal Konteyner	400	110 cm	60 cm	60 cm	Gövde tek parça kıvrılıp; gövde ve yanlar preslenmiş, mukavemet arttırılmıştır. TSE 840-2 belgelidir
Metal Konteyner	600	110 cm	63 cm	85 cm	
Metal Konteyner	800	110 cm	70 cm	100 cm	

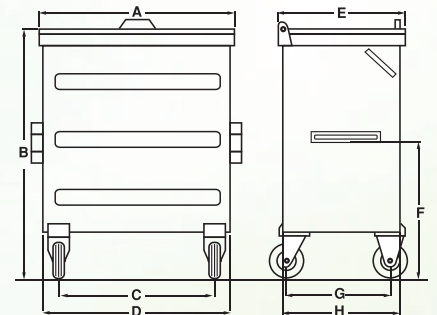

2

2

İÇ MEKAN
SALON
KÜLLÜKLERİ





Ç-107 B | **Ç-107 MB**

Bazuka Küllük | Mega Bazuka Küllük

Ø 30cm x 50cm h | Ø 24cm x 66cm h

* Gövde paslanmaz sac * 0.60 mm Paslanmaz sac gövde
* Üst ve alt kapak DKP sac * Üst ve alt prinç olabilir



Ç-107 YC

Camlı Yuvarlak Küllük

Ø 25cm x 70cm h

* 0.60 mm Paslanmaz sac gövde
* 1.5 mm yuvarlak cam üzeri paslanmaz küllük



Ç-107 KC

Camlı Kare Küllük

25cm x 25cm x 70cm h

* 0.60 mm Paslanmaz sac gövde
* 1.5 mm kare cam üzeri paslanmaz küllük



Ç-107 N

Paslanmaz Nehir Küllük

Ø 31cm x 72cm h

* 0.60 mm Paslanmaz sac
* Üst telli, 4 adet 13 mm boru ayak üzerine



Ç-108 P

Paslanmaz Kumluklu Küllük

Ø 22.5cm x 60cm h

* 0.60 mm Paslanmaz sac gövde, üst tas 0.60 mm
DKP sac boyalı, alt taban 0.60 mm DKP sac boyalı



Ç-108 B

Boyalı Kumluklu Küllük

Ø 22.5cm x 60cm h

* 0.60 mm DKP sac gövde, üst tas 0.60 mm
DKP sac boyalı, alt taban 0.60 mm DKP sac boyalı,
Elektrostatik toz boyalı



Ç-107 M

Meşale Küllük

Ø 32cm x 70cm h

* 38 mm boru, Üst telli
* Taban altı 3 kg döküm



Ç-107 L

Lüks Küllük

Ø 26cm x 70cm h

* 38 mm boru, Üst tas DKP sac boyalı
* Taban altı 3 kg döküm



Ç-105 P

Paslanmaz Mega Küllük

Ø 22.5cm x 60cm h

* 0.60 mm paslanmaz sac gövde,
üst tas 0.60 mm DKP sac boyalı,
üst kapak 0.60 mm paslanmaz, alt taban plastik



Ç-105 B

Boyalı Mega Küllük

Ø 24.5cm x 60cm h

* 0.60 mm DKP sac gövde, üst tas 0.60 mm
DKP sac boyalı, üst kapak 0.60 mm paslanmaz,
alt taban plastik, Elektrostatik toz boyalı



Ç-107 KC

Top Küllük

Ø 24cm X 93cm h

* 51 mm boru

* Alt çap 26 mm, Alüminyum sac



Ç-101

Kare Ayaklı Küllük

Ø 10cm X 10cm X 95cm h



Ç-102

Oval Ayaklı Küllük

Ø 10cm X 85cm h



Ç-104

Duvara Monte Küllük

Ø 18cm X 15cm h



Ç-105

Duvara Monte Uzun Küllük

Ø 18cm X 32cm h



Ç-17

Plastik Modern Küllük

Ø 40cm X 99cm h



Ç-005

Modern Küllük

Ø 35cm X 81cm h



Ç-007

Modern Küllük

Ø 10cm X 106cm h

İÇ MEKAN ÇÖP KUTULARI



Ç-101

Çatı Kapaklı Çöp Kovası

12cm X 18cm X 25cm ve 40cm h

*304 ve 430 kalite, 0,80 mm paslanmaz sac gövde ve kapak



Ç-125

Manuel Kapaklı Çöp Kutusu

Ø 50cm X 50cm h

* 0.70 mm paslanmaz gövde, üst çemberli ve kapalı, 0.70 mm paslanmaz sac kapak, yan ve üst kulplu, sabit ve ya seyyar 4 tekerlekli



Ç-112 S

Sabancı Çöp Kutusu

Ø 31.5cm X 40cm h

* 0.60 mm paslanmaz sac gövde, üst çemberli 0.60 mm paslanmaz sac, üst çember portatif



Ç-103

Ameliyathane Çöp Kovası

Ø 40cm X 50cm h



Ç-112

Pedallı Çöp Kutusu

*304 ve 430 kalite, paslanmaz, pedallı, açılır kapak, iç plastik kova



Ç-112 KP

Paslanmaz Kare Pedallı Çöp Kovası

25cm X 25cm X 53cm h

*0,70 mm 430 kalite sactan imal edilmiştir. Pedal mekanizması tamamen demir aparatlardan oluşmaktadır.



Ç-116

Delikli Battal Boy Çöp Kutusu

Ø 35cm X 70cm h

* 0.70 mm paslanmaz sac gövde, üst kapak 0.70 mm paslanmaz sac



Ç-117 S

Sabancı Çöp Kutusu

* Takım 0.70 mm paslanmaz sac, Duvara monte yarım daire



Ç-112 S

Sabancı Çöp Kutusu

Ø 31cm X 70cm h

* 0.70 mm paslanmaz sac gövde, üst kapak 0.70 mm paslanmaz sac



Ç-128 D

Deri Kaplı Çöp Kovası

Ø 25cm X 30cm h Ø 21cm X 23cm h

*0,60 mm DKP sac gövde, üstü açılır kapak, elektrostatik toz boya üzeri deri kaplama



Ç-110 MÇ

Paslanmaz Mini Çemberli Çöp Kutusu

Ø 21cm X 25cm h

* 0.60 mm paslanmaz sac gövde, üst çember 0.60 mm paslanmaz sac, üst çember portatif



Ç-110 BÇ

Boyalı Çemberli Çöp Kutusu

Ø 24.5cm X 32cm h

* 0.60 mm DKP sac gövde, üst çember paslanmaz, alt plastik, Elektrostatik toz boyalı



Ç-109 K

Konik Çöp Kutusu

24cm X 24cm X 31.5cm h

* Alt genişlik 17 x 17 cm, 0.50 mm DKP sac gövde, alt ayak plastik papuğu, Elektrostatik toz boyalı



Ç-113

Delikli Çöp Kutusu

Ø 24.5cm X 32cm h

* 0.60 mm DKP delikli sac gövde, üst ve alt taban plastik, Elektrostatik toz boyalı



Ç-201

Ateş Söndüren Çöp Kutusu

46 cm X 71cm h

GERİ DÖNÜŞÜM ÜNİTELERİ



ÇY-06

Karizma Çöp Ayrım Ünitesi

50cm X 50cm X 100cm h

* 1 mm DKP sac, üst yarım yuvarlak geniş yaylı kapak, arkadan kapılı, iç kova 1 m DKP sac, 4 adet tekerlek, Elektrostatik toz boyalı



ÇAK-602A

Daire Çöp Ayrım Ünitesi

130cm X 50cm X 75cm h



Ç-16

Tekno Çöp Ayrım Ünitesi

66cm X 93cm X 70cm h

* 1 mm DKP sac, yaylı önden açma kapak, üst kapak eğimli ve çıkmalı, Elektrostatik toz boyalı



ÇY-04

Çağdaş Çöp Ayrım Ünitesi

30cm X 30cm X 87cm h

* 1 mm DKP sac, yaylı önden açma kapak, üst kapak eğimli ve çıkmalı, Elektrostatik toz boyalı



Ç-03

Elips Çöp Ayrım Ünitesi

36cm X 104cm X 80cm h



Ç-119

Şimal Çöp Ayrım Ünitesi

44cm X 150cm X 70cm h



ÇP-07

Şişe Atık Ünitesi

48cm X 55cm X 93cm h

* 120 lt



Ç-20

Pil Atık Kutuları



Ç-120

Şeffaf Pil Atık

Ø 18cm X 50cm X 70cm X 80cm h

PARK ve
BAHÇE
ÇÖP
KUTULARI



Ç-115

Bahçe Çöp Kutusu

Ø 28cm X 105cm h

* 48 mm boru, Gövde 55 cm h, üst tas küllüklü,
4 ayaklı yere monte, 0.60 mm DKP sac,
Elektrostatik toz boyalı



Ç-115 T

Tek Ayaklı Bahçe Çöp Kutusu

Ø 28cm X 105cm h

* 48 mm boru, Gövde 55 cm h, üst tas küllüklü,
2 ayaklı yere monte, 0.60 mm DKP sac,
Elektrostatik toz boyalı



Ç-115 U

U Tipi Bahçe Çöp Kutusu

Ø 28cm x 67cm h

* U boru genişliği 44 cm, 48 mm boru,
Gövde 55 cm h, üst tas küllüklü,
Elektrostatik toz boyalı



Ç-115 S

Sapan Bahçe Çöp Kutusu

Ø 28cm X 125cm h

* 48 mm boru, Gövde 55 cm h, üst tas küllüklü,
Yere monte, 0.60 mm DKP sac,
Elektrostatik toz boyalı



Ç-115 H

Dereli Bahçe Çöp Kutusu

Ø 31.5cm x 125cm h

* 48 mm boru, Gövde 55 cm h,
0.60 mm DKP sac, Ayak aralığı 45 cm,
Boru 1.2 mm et kalınlığı, Elektrostatik toz boyalı



Ç-115 P

Poşet Takılabilir Çöp Kutusu

Ø 35cm x 90cm h

* Çift kapaklı poşet tutucu, 51 mm boru,
Elektrostatik toz boyalı



Ç-102

Sultan Çöp Kovası

50cm X 50cm X 75cm h



Ç-104

Sur Çöp Kovası

45cm X 102cm h



Ç-119 P

Papatya Park Kafes Çöp Kutusu

Ø 50cm x 85cm h

* 1 x 20 mm lama, iç kovalı,
üst ağız boru kıvrımlı, Elektrostatik toz boyalı



Ç-119 A

Ahşap Lamalı Kafesli Çöp Kutusu

Ø 42cm x 77cm h

* 2 x 20 mm lama çevreli,
Alt üst lama bağlantısı 0.80 mm sac,
Lama üzeri 2 cm kalınlığında fırınlanmış
ağaç kaplı, Gövde Elektrostatik toz boyalı



Ç-119 PA

Ahşaplı Papatya Çöp Kutusu

Ø 50cm x 85cm h

* 1 x 20 mm lama üzeri 2 cm genişliğinde
lama çevreli, iç kovalı, üst ağız boru kıvrımlı,
Elektrostatik toz boyalı



PASPASLAR

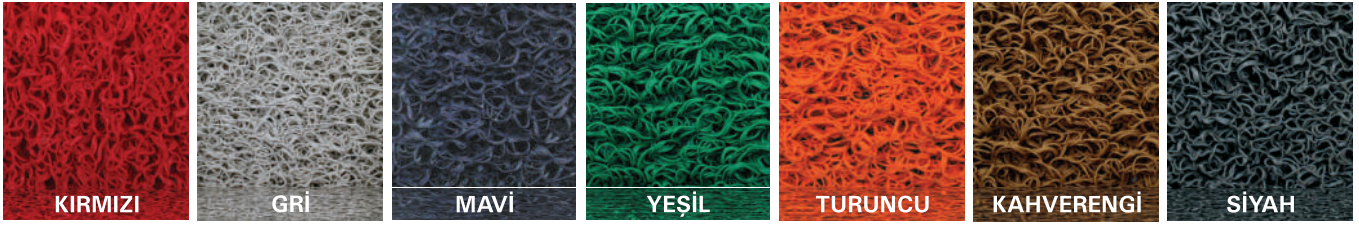

DİŞ MEKAN VE İÇ MEKAN PASPASLAR

ALEV ALMAZ

TUTUŞMAZ

ANTİSTATİK

Açık ağ yapısı ve iç kısımda bulunan hava kanalları, alt yüzeye alt yüzeye inen nem ve ıslaklığın mükemmel hava sirkülasyonu sayesinde çabucak kurummasını sağlar. Küf oluşumunu engeller.

Altı kapalı kıvrıkcık paspas
Kaymayı %100 önleyen saf PVC taban kiri ve suyu tutar. Biriken suyun ve kirin döşemeye sızmasını engeller ve ekstra konfor sağlar.

Kıvrıkcık Paspas Rulo Ebatları
En: 122 cm Boy: 12 m
En: 100 cm Boy: 15 m

Kıvrıkcık bukleli açık ağ yapısı ayakkabıdaki kiri ve çamuru kazıyarak temizler ve buklelerin arasından aşağıya bırakarak paspas yüzeyinin her zaman temiz kalmasını sağlar.

Altı açık kıvrıkcık paspas
Islaklık paspasın içinden süzülerek aşağıya akar ve ıslandığı zaman içerisinde mikrop üremez

KİMYASALLARA DAYANIKLIDIR

SİLİKON TABAN TAKVİYELİDİR KAYMAZ

UV KORMALIDIR RENGİ SOLMAZ



Kıvrıkcık Paspas Rulo Ebatları

En: 122 cm Boy: 12 m
En: 100 cm Boy: 15 m

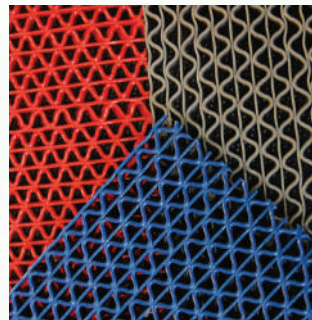

Islak Zemin Paspası

Rulo Ebatları

5mm/en:
0,90cm x 15mt boy
1,20cm x 15mt boy
8mm/en:
1,20cm x 12mt boy



ISLAK ZEMİN PASPASI



**ISLAK
ZEMİN
PASPASLARI**

NEM ALICI PASPAS

50 cm x 80 cm
60 cm x 90 cm
90 cm x 150 cm
100 cm/en x 15 m/boy
120 cm/en x 15 m/boy



PVC Tabanlı Rulo
* İstenilen Ölçüde Üretilir



HIJYEN TAVALI PASPAS

- * Sürekli temizlik ve hijyen sağlar.
- * Kolay temizlenir.
- * Zemin üzerinde kaymayı önleyici Anti-Slip taban.
- * Endüstriyel ve temizlik kimyasallarına dayanıklı özel vinil.
- * Uzun süreli kullanım.

Büyük Boy : 55 cm x 105 cm
Orta Boy : 60 cm x 90 cm
Küçük Boy : 45 cm x 75 cm
Serbest Ölçü : x cm
"İstenilen Ölçüde Hazırlanır."

Hijyen Tavalı Paspas Kullanım Özellikleri:

Tavaya dökülecek dezenfektan sıvı paspas üzerine basıldığında tüm ayakkabı tabanını sararak istenmeyen bakteri, küf maya, mantar ve benzeri virüsleri dezenfekte ederek iç mekanlara geçmesini engeller, olası kir, toz ve küçük partikülleri ise yüzeyden arındırarak tava dibine biriktirir.

Hijyen Tavalı Paspas Kullanım Alanları:

Özellikle et ve süt tabanlı üretim yapan kuruluşlar ile her türlü gıda üretim tesisleri, sağlık tesisleri ile yasaaların ve ihtiyaçların öngördüğü mekanlarda yoğun ve güvenli olarak kullanılır.

HIJYEN YAPRAK PASPAS

Hijyen Yaprak Paspas Kullanım Özellikleri :

Kontrollü temiz alanlara partiküllerin girişini engeller, kontaminasyonu önler. Paspasın Kullanım alanları tıbbi üretim tesisleri, ilaç üretim, mikroelektronik, uçak ve nükleer endüstrisi, doktor ve dişi ziyaret odaları, poliklinikler ve hastanelerdir.



Hijyen Yaprak Paspas Kullanım Özellikleri :

30 veya 40 yapraklık pedlerden oluşmakta ve her yaprak yüksek yapışkanlı antimikrobiyal bir malzeme ile kaplanmıştır. Yüzey kirlendiğinde üstteki yaprak alınarak yeni ve temiz bir yüzey elde edilir. 0 (sıfır toz kontrolü)

PASPAS ÖLÇÜLERİ :

Ebat: 45 cm X 115 cm

ALÜMİNYUM DIŞ PASPAS



Küçük Boy : 69 x 46 cm
Orta Boy : 89 x 55 cm
Büyük Boy : 109 x 64 cm
Serbest Ölçü : x cm

* İstenilen Ölçüde Üretilir

SUNİ ÇİM HALI



Suni Çim Paspas Ebatları

En / cm	Boy / cm	m ²
100	25	25
200	25	50
400	25	100



ALÜMİNYUM İÇ PASPAS



KAYDIRMAZ BANT

15 mm x 25 m
15 mm x 50 m
15 mm x 100 m
25 mm x 25 m

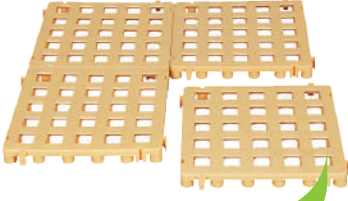

Ç-1201

Kod	1201
Adı	101 Plastik Izgara
Ebat	27,5*27,5*2 cm
1 koli	4m ²
1m ²	14 Ad.
Koli kg.	15,00
Koli m ³	0,06

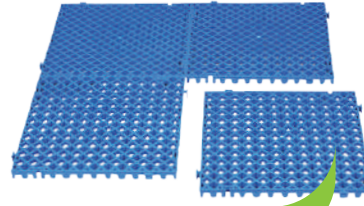

Ç-1210

Kod	1210
Adı	105 Plastik Izgara
Ebat	26*26*1,5 cm
1 koli	5m ²
1m ²	11 Ad.
Koli kg.	15,00
Koli m ³	0,60

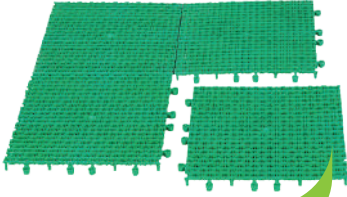

Ç-1211

Kod	1211
Adı	120 Plastik Izgara
Ebat	25*25*1,5 cm
1 koli	10m ²
1m ²	16 Ad.
Koli kg.	19,50
Koli m ³	0,09

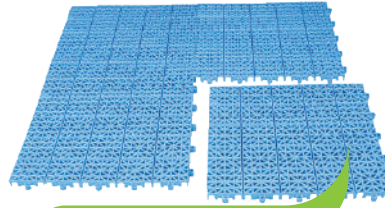

Ç-1213

Kod	1213
Adı	133 Plastik Izgara
Ebat	33,3*33,3*2 cm
1 koli	6 m ²
1m ²	9 Ad.
Koli kg.	22,00
Koli m ³	0,07

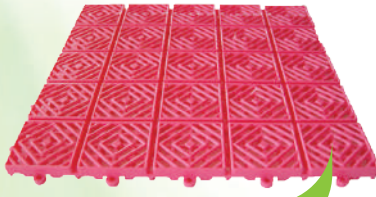

Ç-1214

Kod	1214
Adı	134 Plastik Izgara
Ebat	30*30*1,5 cm
1 koli	6 m ²
1m ²	11 Ad.
Koli kg.	23,75
Koli m ³	0,08

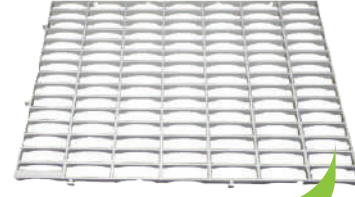

Ç-1215

Kod	1215
Adı	150 Plastik Izgara
Ebat	50*50*2,5 cm
1 koli	5 m ²
1m ²	4 Ad.
Koli kg.	18,00
Koli m ³	0,09



Ç-1200

Kod	1245
Adı	Yer Karosu
Ebat	50 x 50 x 2,5
1 koli	5m ² /20 Adet
1m ²	4 Ad.
Koli kg.	19,50
Koli m ³	0,13

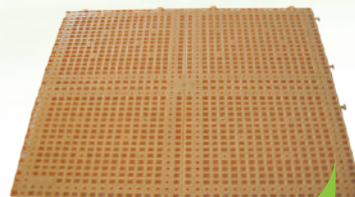

Ç-1217

Kod	1217
Adı	160 Plastik Izgara
Ebat	50*50*1 cm
1 koli	6m ²
1m ²	4 Ad.
Koli kg.	15,00
Koli m ³	0,08

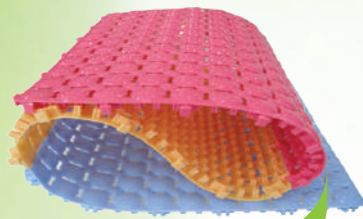

Ç-1212

Kod	1212
Adı	132 Plastik Izgara
Ebat	33,3 x 33,3 x 1,5 cm
1 koli	6m ² /54 Adet
1m ²	9 Ad.
Koli kg.	18,10
Koli m ³	0,098



Ç-1220

Kod	1220
Adı	170 Plastik Izgara
Ebat	30*30*1,5 cm
1 koli	5m/55 adet
1m ²	11 Ad.
Koli kg.	15,00
Koli m ³	0,06



**BAĞ ve
BAHÇE
KASALARI**



TEKNE 6600

100cm X 120cm X 76cm h | 38000gr
"Altı kapalı, yanları kapalı, sapı kapalı"



Aksesuarlı Görünüm

TEKNE 5500

80cm X 120cm X 80cm h Tekerli Yüks. 96cm h | 23000gr
"Altı kapalı, yanları kapalı, sapı kapalı"



TEKNE 3200

80cm X 80cm X 76cm h
Tekerli Yüks. 88.6cm h | 16500gr
"Altı kapalı, yanları kapalı, sapı kapalı"



TEKNE 2900

66cm X 100cm X 69.5cm h
Tekerli Yüks. 82.5cm h | 11000gr
"Altı kapalı, yanları kapalı, sapı kapalı"



TEKNE 2700

66cm X 104cm X 67cm h
Tekerli Yüks. 79cm h | 13500gr
"Altı kapalı, yanları kapalı, sapı kapalı"



KONTEK 2500

43cm X 101cm X 60cm h
Tekerli Yüks. 73cm h | 10000gr
"Altı kapalı, yanları kapalı, sapı kapalı"



KOPS 2000 K

61cm X 81cm X 48cm h
Tekerli Yüks. 64cm h | 7250gr
"Altı kapalı, yanları kapalı, sapı kapalı"



KOPS 2000 A

61cm X 81cm X 48cm h
Tekerli Yüks. 64cm h | 6800gr
"Altı kapalı, yanları açık, sapı açık"



KONTEK 99

58cm X 37cm X 60cm h
Tekerli Yüks. 70cm h | 3200gr
"Altı kapalı, yanları kapalı, sapı kapalı"



KOD 2301 K

50.5cm X 70.5cm X 28cm h
Tekerli Yüks. 37.5cm h | 3850gr
"Altı kapalı, yanları kapalı, sapı kapalı"



KOD 2501 K

50cm X 70cm X 46.5cm h
Tekerli Yüks. 56cm h | 5300gr
"Altı kapalı, yanları kapalı, sapı kapalı"



KAZAN 75

55cm X 48cm X 40cm h | 3290gr



KÜFE

63 LT.



KOPS 8622

60cm X 80cm X 23.5cm h | 4140gr
"Altı kapalı, yanları kapalı, sapı açık"



KOPS 8632-KOPS 134

60cm X 80cm X 32cm h | 6050gr
"Altı kapalı, yanları kapalı, sapı kapalı"



KOPS 8612

60cm X 80cm X 12.5cm h | 3250gr
"Altı kapalı, yanları kapalı, sapı kapalı"



KOPS 28

41cm X 56.5cm X 28cm h | 2570gr
"Altı kapalı, yanları kapalı, sapı kapalı"



KOPS 38

41cm X 56.5cm X 37cm h | 3180gr
"Altı kapalı, yanları kapalı, sapı kapalı"



TK 9

20cm X 30cm X 20cm h | 850gr
"Altı kapalı, yanları kapalı, sapı açık"



TKN 4300
Kapak

TK 15

30cm X 40cm X 15cm h | 890gr
"Altı kapalı, yanları kapalı, sapı kapalı"



TKN 4300
Kapak

TK 28 A

30cm X 40cm X 30cm h | 1350gr
"Altı kapalı, yanları kapalı, sapı kapalı"



STK 29 K

40cm X 60cm X 15cm h | 1650gr
"Altı kapalı, yanları kapalı, sapı kapalı"

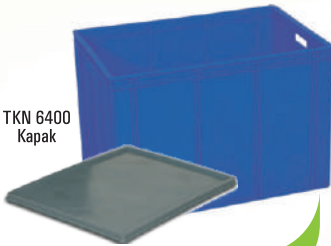

TKN 6400
Kapak

STK 82 K

40cm X 60cm X 42cm h | 4020gr
"Altı kapalı, yanları kapalı, sapı açık"



STK 39 K

40cm X 60cm X 20cm h
"Altı kapalı, yanları kapalı, sapı kapalı"



STK 690

40cm X 60cm X 34cm h | 3050gr
"Altı kapalı, yanları kapalı, sapı açık"



SYL 4420 K

40cm X 40cm X 20cm h | 1690gr
"Altı kapalı, yanları kapalı, sapı kapalı"



SYL 4432 K

40cm X 40cm X 32cm h | 2400gr
"Altı kapalı, yanları kapalı, sapı kapalı"



SC-6542

50cm X 60cm X 42.5cm h
"Altı kapalı, yanları kapalı, sapı kapalı"



SLC 1322

30_{cm} X 100_{cm} X 22_{cm} h | 2300gr
"Altı kapalı, yanları kapalı, sapı kapalı"



SLC 3212

20_{cm} X 30_{cm} X 12_{cm} h | 525gr
"Altı kapalı, yanları kapalı, sapı kapalı"



TKN 4300
Kapak

KOPS 4312

40_{cm} X 30_{cm} X 12_{cm} h | 850gr
"Altı kapalı, yanları kapalı, sapı kapalı"



SLC 4322

40_{cm} X 30_{cm} X 22_{cm} h | 1200gr
"Altı kapalı, yanları kapalı, sapı kapalı"



TKN 5800
Kapak

SLC 6422

40_{cm} X 60_{cm} X 22_{cm} h | 1950gr
"Altı kapalı, yanları kapalı, sapı kapalı"



SLC 6432

40_{cm} X 60_{cm} X 32_{cm} h | 2800gr
"Altı kapalı, yanları kapalı, sapı kapalı"



SLC 8422

40_{cm} X 80_{cm} X 23_{cm} h | 3235gr
"Altı kapalı, yanları kapalı, sapı açık"



SLC 12530

49_{cm} X 119_{cm} X 32_{cm} h | 5350gr
"Altı kapalı, yanları kapalı, sapı kapalı"



KSK 3011

30_{cm} X 40_{cm} X 11.8_{cm} h | 520gr
"Altı kapalı, yanları kapalı, sapı kapalı"



KSK 3017

30_{cm} X 40_{cm} X 17.5_{cm} h | 1000gr
"Altı kapalı, yanları kapalı, sapı kapalı"



KSK 3023

30_{cm} X 40_{cm} X 23_{cm} h | 1200gr
"Altı kapalı, yanları kapalı, sapı açık"



KSK 6017

40_{cm} X 60_{cm} X 17_{cm} h | 1700gr
"Altı kapalı, yanları kapalı, sapı açık"



KSK 6023

40_{cm} X 60_{cm} X 23_{cm} h | 1950gr
"Altı kapalı, yanları kapalı, sapı açık"



KSK 6034

40_{cm} X 60_{cm} X 34_{cm} h | 2800gr
"Altı kapalı, yanları kapalı, sapı açık"



F-26

38,5_{cm} X 48,5_{cm} X 17,5_{cm} h
"Altı kapalı, yanları kapalı, sapı kapalı"



KP 60

47_{cm} X 72_{cm} X 30_{cm} h



K-15 BK

25,5cm X 50cm X 16cm h
"Altı kapalı, yanları kapalı, sapı kapalı"



K 18 K

29cm X 50cm X 18cm h | 1300gr
"Altı kapalı, yanları kapalı, sapı kapalı"



K 20 BK

25.5cm X 50cm X 22cm h | 1280gr
"Altı kapalı, yanları kapalı, sapı kapalı"



K 27 K

29cm X 50cm X 23.5cm h | 1630gr
"Altı kapalı, yanları kapalı, sapı kapalı"



Kapak
40 x 60

K 180 K

40cm X 60cm X 10cm h | 1950gr
"Altı kapalı, yanları kapalı, sapı kapalı"



KNK 5430 K

37cm X 53cm X 31cm h | 2200gr
"Altı kapalı, yanları kapalı, sapı açık"



KNK 6415 (BALKA 260)

40cm X 60cm X 15.5cm h | 1300gr
"Altı kapalı, yanları kapalı, sapı kapalı"



KNK 6425 K

40cm X 60cm X 25cm h | 2180gr
"Altı kapalı, yanları kapalı, sapı açık"



KNK 6442 K

40cm X 60cm X 42cm h | 3250gr
"Altı kapalı, yanları kapalı, sapı açık"



E 21

35cm X 41cm X 19cm h | 1300gr
"Altı kapalı, yanları kapalı, sapı açık"



ECK-6

24cm X 55cm X 7,5cm h
"Altı kapalı, yanları kapalı, sapı kapalı"



A 24 2050

36cm X 52cm X 13.5cm h | 1250gr
"Altı kapalı, yanları kapalı, sapı kapalı"



C 30

52.5cm X 52.5cm X 15cm h | 1950gr
"Altı kapalı, yanları kapalı, sapı kapalı"



GK 114 K

48cm X 69cm X 43cm h | 4500gr
"Tekerlek Monte Edilebilir"
"Altı kapalı, yanları kapalı, sapı kapalı"



GA-40 K

38cm X 59cm X 21cm h
"Altı kapalı, yanları kapalı, sapı kapalı"



STK-18 A

40cm X 60cm X 10cm h

"Altı açık, yanları açık, sapı açık"



STK-29 A

40cm X 60cm X 15cm h

"Altı açık, yanları açık, sapı açık"



STK-39 A

40cm X 60cm X 20cm h

"Altı açık, yanları açık, sapı açık"



STK-48

40cm X 60cm X 24cm h

"Altı kapalı, yanları açık"



STK-49

40cm X 60cm X 24cm h

"Altı açık, yanları açık, sapı açık"



STK-71

40cm X 60cm X 35cm h | 2450gr

"Altı kapalı, yanları açık, sapı açık"



STK-82 A

40cm X 60cm X 42cm h

"Altı kapalı, yanları açık, sapı açık"



G-55 A

41cm X 62cm X 25,5cm h

"Altı açık, yanları açık, sapı açık"



G-55 B

41cm X 62cm X 9cm h

"Altı açık, yanları açık, sapı açık"



G-55 BE

45cm X 64cm X 14cm h

"Altı açık, yanları açık, sapı açık"



G-55 BY

44cm X 64cm X 14cm h | 1570gr

"Altı açık, yanları açık, sapı açık"



G-55 K

42cm X 62,5cm X 26cm h

"Altı kapalı, yanları açık, sapı açık"



G-55 15

41cm X 62cm X 16cm h

"Altı açık, yanları açık, sapı açık"



D-60 A

36,5cm X 52cm X 31cm h

"Altı açık, yanları açık, sapı açık"



D-60 C

36,5cm X 52cm X 31cm h

"Altı açık, yanları açık, sapı açık"



A-24

37cm X 52,5cm X 17cm h
"Altı açık, yanları açık, sapı açık"



A 24 2000

36cm X 52cm X 13,5cm h | 930gr
"Altı açık, yanları açık, sapı açık"



A-2432

37cm X 52,5cm X 21cm h
"Altı açık, yanları açık, sapı açık"



GA - 40 B

38cm X 59cm X 21cm h
"Altı kapalı, yanları açık, sapı açık"



G-5528

41cm X 62cm X 14cm h
"Altı açık, yanları açık, sapı kapalı"



SK-12

29,5cm X 56cm X 12cm h
"Altı açık, yanları açık, sapı açık"



AS-114

49cm X 70cm X 42cm h
"Altı kapalı, yanları açık, sapı kapalı"



114 A

48cm X 69cm X 43cm h | 3600gr
"Altı kapalı, yanları açık, sapı açık"



MEYKA - 50

36,5cm X 52cm X 31cm h
"Altı açık, yanları açık, sapı açık"



KOD 2501 A

50,5cm X 70,5cm X 46cm h | 3800gr
"Altı kapalı, yanları açık, sapı açık"



B 70

41cm X 56cm X 36,5cm h | 2100gr
"Altı kapalı, yanları açık, sapı açık"



EM-59

39cm X 59cm X 35cm h
"Altı kapalı, yanları açık, sapı kapalı"



EKKA 80

42,5cm X 65,5cm X 39cm h
"Altı kapalı, yanları açık, sapı açık"

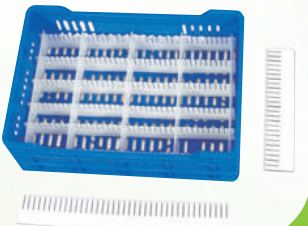

SP TARAK

"Değişik ölçülerde tarak seperatör"



BURGER KASA

53,5cm X 63cm X 12cm h
"Altı açık, yanları açık, sapı açık"

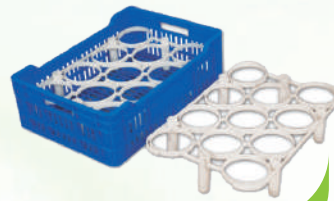

SP 11

Çapı: 104mm
"11 gözlü seperatör"

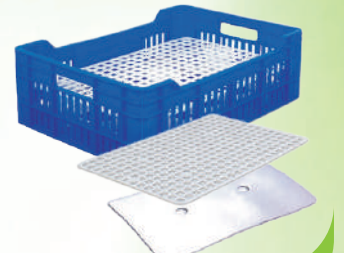

DELİKLİ SEPERATÖR

32mm X 47mm

PLASTİK PALETLER





P 60x80 KS

60cm X 80cm X 15cm h | 5160gr
"Üstü Kapalı, Zemini Setli"



P 80x120 KM

80cm X 120cm X 15cm h | 10200gr



P 80x120 KMS

80cm X 120cm X 15cm h | 10200gr



P 80x120 KY

80cm X 120cm X 15cm h | 13900gr



P 80x120 A

80cm X 120cm X 14.5cm h | 11000gr
"üstü delikli"



KP 80x120

80cm X 120cm X 16cm h | 12000gr



P 80x120 TP

80cm X 120cm X 14cm h | 7800gr
"Transport iç içe geçebilir,
üstü delikli yanları papuçlu"



P 80x120 KYR

80cm X 120cm X 17.5cm h | 21250gr
"Raf kullanımına uygun, üstü kapalı,
yanları papuçlu"

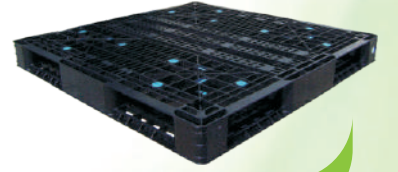

110x110

110cm X 110cm X 12cm h | 10200gr



P 100x120 A

100cm X 120cm X 15.5cm h | 17150gr
"Üstü delikli"

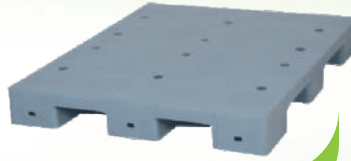

P 100x120 K

100cm X 120cm X 14.5cm h | 15800gr

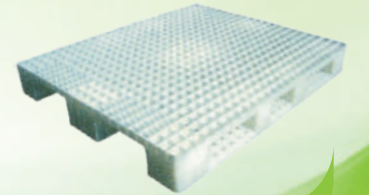

100x120 G

120cm X 100cm X 14.5cm h | 13300gr



P 100x120 KR

100cm X 120cm X 16.5cm h | 24800gr
"Raf kullanımına uygun,
üstü kapalı yanları papuçlu"



P 110x120 TP

100cm X 120cm X 14cm h | 8750gr
"Transport iç içe geçebilir,
üstü delikli yanları papuçlu"



YÜKÇEK 6383

62cm X 82cm X 22.5cm h | 10000gr
YÜKÇEK 4363
43cm X 63cm X 21cm h | 6650gr
"altı kapalı zemini düz ve yanları setli"

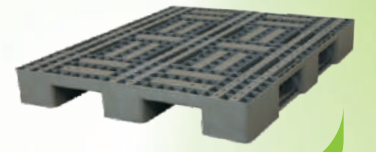

P 1100x130 A

110cm X 130cm X 15.5cm h | 21700gr
"Üstü delikli"

BAHÇE
GRUBU
ÜRÜNLERİ

Sandalyeler



Napoleon



Napoleon Renkli



Tiffany



Capri



Gozo



Kristal Sandalye



Kral Sandalye



Plastik Masalar
70 x 120 / 80 x 140

Rattan Bahçe Takımı



Akdeniz Beyaz Şezlong



Plastik Bank



Portmantolar



Ahşap Banklar



Avadanlık Kutular



STAND 1

1080mm X 470mm X 1600mm h
100 Adet



STAND 3

1100mm X 400mm X 1970mm h
100 Adet



STAND 7

710mm X 710mm X 1750mm h
100 Adet



A-100

100mm X 72mm X 163mm h



A-150

128mm X 96mm X 204mm h



A-200

148mm X 255mm X 114mm h



A-250

184mm X 304mm X 129mm h



A-300

219mm X 368mm X 148mm h



A-350

264mm X 434mm X 168mm h



A-400

314mm X 505mm X 191mm h



A-500

490mm X 400mm X 300mm h



PA-315

173mm X 307mm X 150mm h



PA-415

173mm X 402mm X 150mm h



PA-515

253mm X 402mm X 150mm h



PA-520

253mm X 402mm X 200mm h



PA-540

340mm X 503mm X 200mm h



PA-550

340mm X 503mm X 250mm h

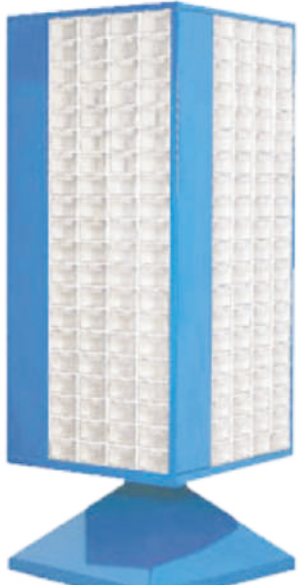

MT 105

63cm X 63cm X 168cm h

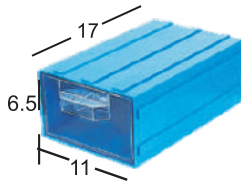

105 = 320 adet

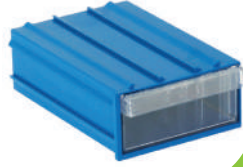

102

85mm X 122mm X 41mm h



202

100mm X 138mm X 52mm h

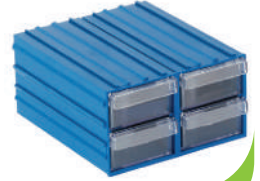

300

110mm X 122mm X 58mm h



304

103mm X 135mm X 83mm h



306

103mm X 135mm X 83mm h



302

106mm X 121mm X 60mm h



202-2

103mm X 135mm X 83mm h



302-3

103mm X 135mm X 83mm h



104

84mm X 135mm X 103mm h



102-3

84mm X 135mm X 103mm h

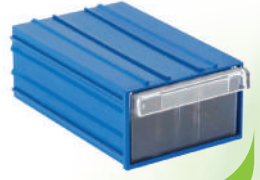

105

110mm X 170mm X 65mm h

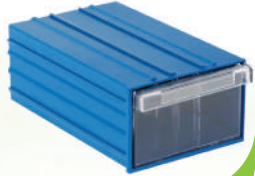

120

123mm X 200mm X 80mm h

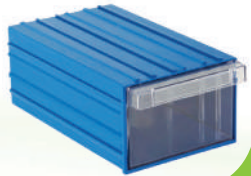

140

136mm X 230mm X 96mm h



120-3

370mm X 204mm X 160mm h



120-4

370mm X 204mm X 160mm h



120-6

370mm X 204mm X 160mm h



120-9

370mm X 204mm X 160mm h

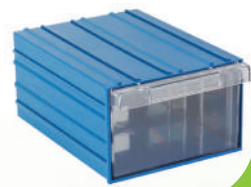

175

173mm X 230mm X 110mm h

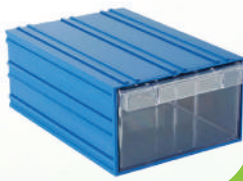

501

210mm X 302mm X 124mm h



501-2

210mm X 302mm X 124mm h

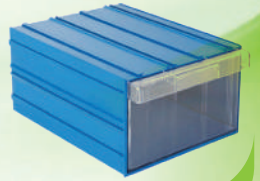

510

260mm X 340mm X 150mm h

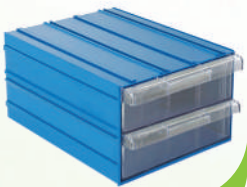

512

260mm X 340mm X 150mm h

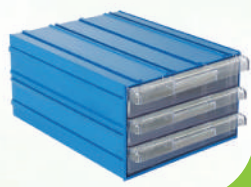

513

260mm X 340mm X 150mm h



C120

123mm X 200mm X 80mm h

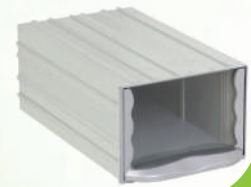

C140

137mm X 226mm X 95mm h



MS-2

120mm X 110mm X 160mm h



Ç-3 / LT.

75cm X 56cm X 49cm h
* 3 LT.



Ç-4 / LT.

75cm X 56cm X 52cm h
* 4 LT.



Enfekte Atık Kovası / LT.

* 1.2 LT



Ç-5 / LT.

75cm X 48.5cm X 53.5cm h
* 5 LT.



Ç-8 / LT.

27cm X 21cm
* 8 LT.



Ç-10 / LT.

81.5cm X 55cm X 52cm h
* 10 LT.



Ç-60 / LT.

42cm X 42cm X 122cm h
* 30 LT.



Ç-30 / LT.

40cm X 40cm X 125cm h
* 30 LT.



Ç-30 / LT.

40cm X 40cm X 125cm h
* 30 LT



Ç-30 / LT.

40cm X 40cm X 125cm h
* 30 LT.

*Patalojik Atık Varil



Ç-40 / LT.

Tıbbi Atık Pedallı Kova



Enfekte Atık Poşeti



ÇTA-5109

87cm X 63cm X 90cm h
* 250 LT.
Kapaklı Çamaşır Toplama



Ç-15

Marifetli Temizlik Seti



Ç-10

Kapaklı Variller



Geri Dönüşüm Kutuları



PEDALLI 50 LT.



PEDALLI 70 LT.



ÇÖP KOVASI (52 LT)



2'Lİ TEMİZLİK SETİ



SAPLI SÜPÜRGE



SAPLI FARAŞ

Trafik Malzemeleri



Çekmeli Yönlendirme Bariyeri



Plastik Duba



PLASTİK ZİNCİR



Esnek Kırılmaz Dikme



Plastik Bariyer